



AM/FM STEREO CD DUAL ALARM CLOCK RADIO



OWNER'S MANUAL

KT2053

CAUTION – ELECTRICALLY OPERATED PRODUCT:
Not recommended for children under 8 years of age. As with all electric products, precautions should be observed during handling and use to prevent electric shock.

SAFETY INSTRUCTIONS

WARNING: TO PREVENT FIRE OR SHOCK HAZARD, DO NOT EXPOSE THIS APPLIANCE TO RAIN OR MOISTURE.

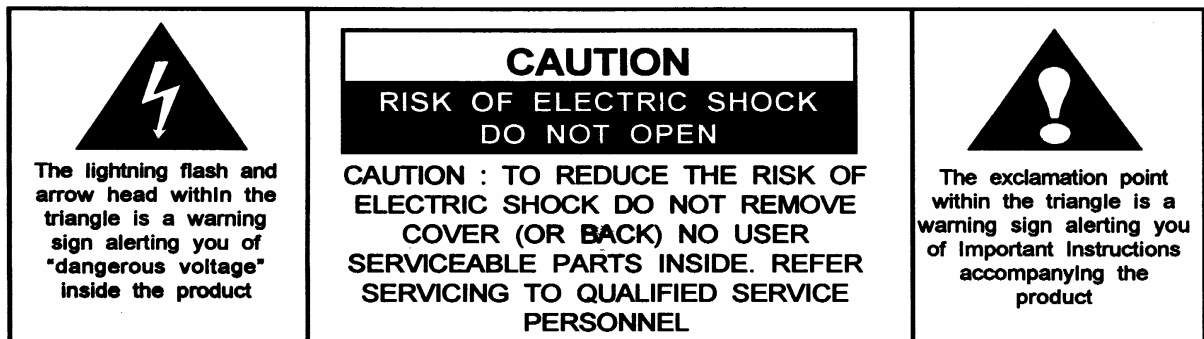

THE IMPORTANT SAFETY INSTRUCTIONS SHALL INCLUDE, AS APPLICABLE TO THE APPLIANCE, STATEMENTS THAT CONVEY TO THE USER THE INFORMATION ITEMIZED IN THIS PARAGRAPH:

1. Read instructions - All the safety and operating instructions should be read before the appliance is operated
2. Retain instructions - The safety and operating instructions should be retained for future reference.
3. Heed Warnings - All warnings on the appliance and in the operating instructions should be adhered to.
4. Follow instructions - All operation and use instructions should be followed.
5. Water and Moisture - The appliance should not be used near water; for example, near a bathtub, washbowl, kitchen sink, laundry tub, in a wet basement, or near a swimming pool, and the like.
6. Carts and Stands - The appliance should be used only with a cart or stand that is recommended by the manufacturer.
An appliance and cart combination should be moved with care. Quick stops, excessive force, and uneven surfaces may cause the appliance and cart combination to overturn.
7. Wall and Ceiling Mounting - The appliance should be mounted to a wall or ceiling only as recommended by the manufacturer.
8. Ventilation - The appliance should be situated so that its location or position does not interfere with its proper ventilation. For example, the appliance should not be situated on a bed, sofa, rug, or similar surface that may block the ventilation openings; or placed in a built-in installation, such as a bookcase or cabinet that may impede the flow of air through the ventilation openings.
9. Heat - The appliance should be situated away from heat sources such as radiators, heat registers, stoves or other appliances (including amplifiers) that produce heat.
10. Power Sources - The appliance should be connected to a power supply only of the type described in the operating instructions or as marked on the appliance.
11. Grounding or Polarization - Precautions should be taken so that the grounding or polarization means of an appliance is not defeated.
12. Power-Cord Protection - Power supply cords should be routed so that they are not likely to be walked on or pinched by items placed upon or against them, paying particular attention to cords at plugs, convenience receptacles and the point where they exit from the appliance.
13. Protective Attachment Plug - The appliance is equipped with an attachment plug having overload protection. This is a safety feature. See Instruction Manual for replacement or resetting of protective device. If replacement of the plug is required, be sure the service technician has used a replacement plug specified by the manufacturer that has the same overload protection as the original plug.
14. Cleaning - The appliance should be cleaned only as recommended by the manufacturer.
15. Power Lines - An outdoor antenna should be located away from power lines.



16. Outdoor Antenna Grounding - If an outside antenna is connected to the receiver, be sure the antenna system is grounded so as to provide some protection against voltage surges and built up static charges. Section 810 of the National Electrical Code, ANSI/ NFPA No.70-1984, provides information with respect to proper grounding of the mast and supporting structure, grounding of the lead-in wire to an antenna discharge unit, size of grounding conductors, location of antenna discharge unit, connection to grounding electrodes, and requirements for the grounding electrode. See figure 1.

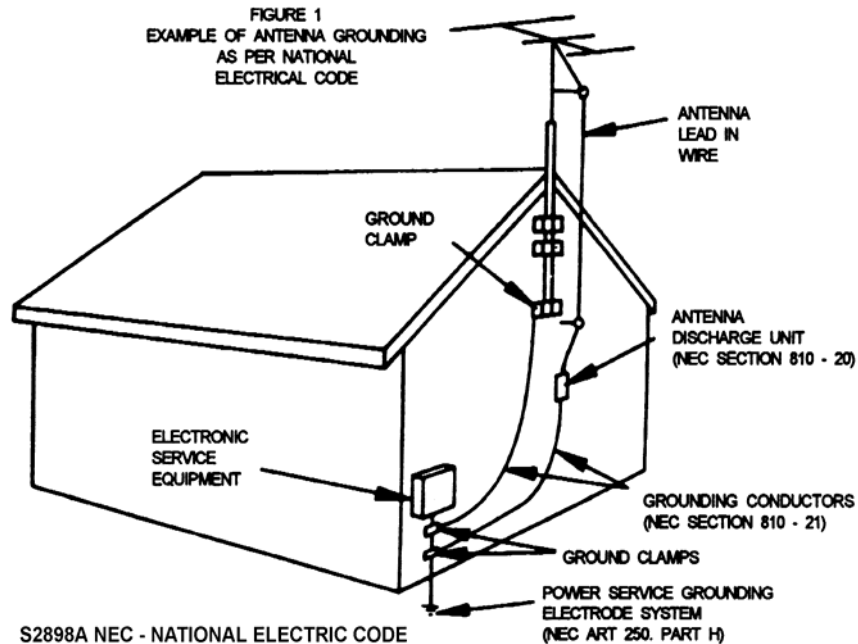

17. Nonuse Periods - The power cord of the appliance should be unplugged from the outlet when left unused for a long period of time.
18. Object and Liquid Entry - Care should be taken so that objects do not fall and liquids are not spilled into the enclosure through openings.
19. Damage Requiring Service - The appliance should be serviced by qualified service personnel when:
- A. The power supply cord or the plug has been damaged; or
 - B. Objects have fallen, or liquid has been spilled into the appliance; or
 - C. The appliance has been exposed to rain; or
 - D. The appliance does not appear to operate normally or exhibits a marked change in performance;
- or
- E. The appliance has been dropped, or the enclosure damaged.
20. Servicing - The user should not attempt to service the appliance beyond that described in the operating instructions. All other servicing should be referred to qualified service personnel.

CAUTION: TO PREVENT ELECTRIC SHOCK, MATCH WIDE BLADE OF PLUG TO WIDE SLOT, FULLY INSERT.

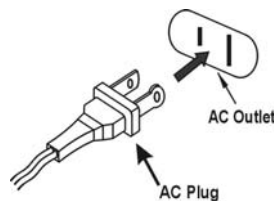

ADDRESS TO PARENTS:

It is recommended that the product to be periodically examined for conditions that may result in the risk of fire, electric shock, or injury to persons and that, in an event such conditions, the product should not be used until properly repaired.

CAUTION

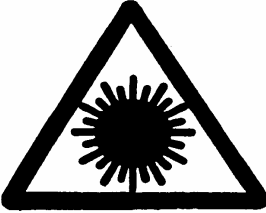
CLASS 1 LASER PRODUCT		
CLASS 1 LASER PRODUCT APPAREIL LASER DE CLASSE 1 PRODUCTO LASER DE CLASE 1	CAUTION INVISIBLE LASER RADIATION WHEN OPEN AND INTERLOCKS DEFEATED. AVOID EXPOSURE TO BEAM	
This product contains a low power laser device.		

Follow the advice below for safe operations.

ON PROTECTION AGAINST LASER ENERGY EXPOSURE

- As the laser beam used in this compact disc player is harmful to the eyes, do not attempt to disassemble the casing.
- Stop operation immediately if any liquid or solid object should fall into the cabinet.
- Do not touch the lens or poke at it. If you do, you may damage the lens and the player may not operate properly.
- Do not put anything in the safety slot. If you do, the laser diode will be ON when the CD door is still open.
- If the unit is not to be used for a long period of time, make sure that all power sources are disconnected from the unit. Remove all batteries from the battery compartment, and unplug the AC cord from the wall outlet. Make it a practice to remove the AC cord by grasping the plug and not by pulling the cord.
- This unit employs a laser. The use of controls or adjustment or performance of procedures other than those specified here may result in exposure to hazardous radiation.

ON PLACEMENT

- Do not use the unit in places, which are extremely hot, cold, dusty or humid.
- Place the unit on a flat and even surface.
- Do not restrict the airflow of the unit by placing it in a place with poor ventilation, by covering it with a cloth or by placing it on a carpet.

ON CONDENSATION

- When left in a heated room where it is warm and damp, water droplets or condensation may form inside the unit.
- When there is condensation inside the unit, the unit may not function normally.
- Let it stand for 1 to 2 hours before turning the power on, or gradually heat the room up and dry the unit before use.

Should any trouble occur, remove the power cord and refer servicing to qualified personnel.

LOCATION OF CONTROLS

1. CD DOOR
2. CD DOOR OPEN LID
3. SNOOZE BUTTON
4. PROGRAM INDICATOR
5. LED DISPLAY
6. PLAY/PAUSE ►|| BUTTON
7. PM INDICATOR
8. REPEAT INDICATOR
9. POWER ON INDICATOR
10. BACK/MINUTE ◀◀ BUTTON
11. POWER BUTTON
12. ALARM 1 INDICATOR
13. ALARM 1 BUTTON
14. DISPLAY BUTTON
15. SLEEP BUTTON
16. PLAY MODE BUTTON
17. ALARM 2 BUTTON
18. ALARM 2 INDICATOR
19. CD STOP ■ / CLOCK BUTTON
20. PROGRAM BUTTON
21. NEXT/HOUR ►► BUTTON
22. FM STEREO INDICATOR
23. RANDOM INDICATOR
24. SPEAKERS
25. VOLUME CONTROL
26. FUNCTION SELECTOR (CD/FM/AM/BUZZER)
27. TUNING CONTROL/DIAL INDICATOR
28. FM ANTENNA WIRE
29. FM MODE SELECTOR (MONO/STEREO)
30. DIMMER SWITCH (LOW/HI)
31. BATTERY COMPARTMENT
32. AC POWER CORD

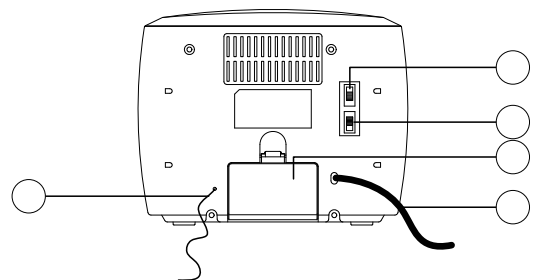
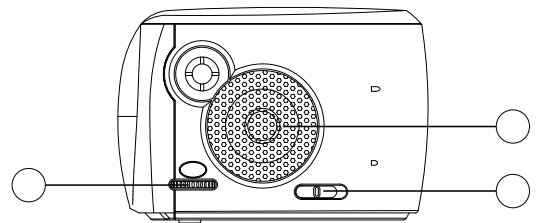
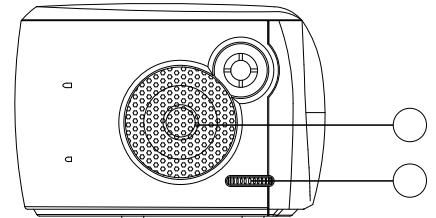
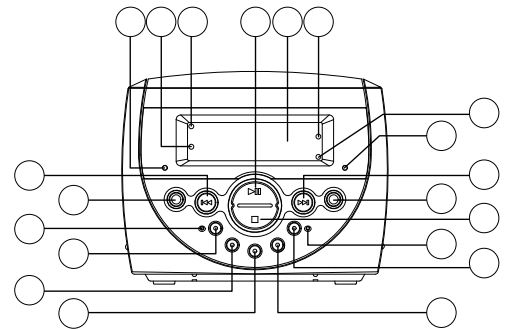
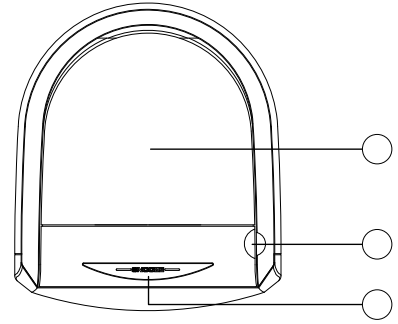

POWER SOURCE

This AM/FM Stereo CD Dual Alarm Clock Radio operates from AC 120V 60Hz line power supply. A 9V alkaline battery (not included) is also required to retain the normal and alarm time settings in the event of a power outage.

AC OPERATION

Plug the AC Power Cord into the AC 120V 60Hz power source.

BACKUP BATTERY INSTALLATION

1. Open the Battery Compartment Door, following the polarity diagram shown in the Battery Compartment, connect one DC 9V battery (not included) to the battery clip which only fits one way to ensure the correct polarity.
2. Replace the Battery Compartment Door.
IMPORTANT: Be sure that the battery is installed correctly. Wrong polarity may damage the unit.
3. For better performance and longer operating time, we recommend the use of alkaline-type battery.
4. If the unit is not to be used for an extended period of time, remove the battery. Old or leaking battery can cause damage to the unit and will void the warranty.
5. Do not dispose of battery in fire. Battery may leak or explode.

TIME SETTING

Note: In order for the clock to function properly, the clock has to be set the first time you use the Unit.

The following procedure illustrates the setting of the Clock at 2:15 PM.

1. Connect the AC cord to an AC 120V 60Hz power outlet. Make sure to use an outlet that is always "live". Do not use an outlet that is controlled by a wall switch.
2. When the unit is plugged in the first time, the Display will show flashing "12:00" (AM).



3. While the Display is flashing, press repeatedly and release the HOUR ►► Button until the correct hour is displayed.

Note: For 12 Hour format, there is a PM INDICATOR (PM) located in the upper left-hand corner of the DISPLAY. This indicator will light when the time range falls within the "PM" range when setting the clock. The time is in the "AM" range if this indicator is not lit. It is important that the "AM" or "PM" setting is correct for proper operation of the Alarm function.

4. Press repeatedly and release the MINUTE ◀◀ Button until the correct minute is displayed.
5. Press the **CLOCK** Button once to complete the setting.



Note: If you want to reset the time, first press the **CLOCK** Button once then repeat steps 3 to 5 to complete the setting.

CHANGING 12/24 HOUR FORMAT

Press and hold the **CLOCK** Button, the clock will change to 24 Hour format, and vice versa.

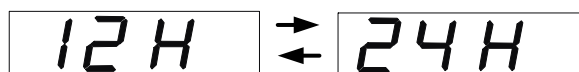

SETTING ALARM TIME

This unit allows you to set two different wake-up times, which you can choose to, use independently or simultaneously AL1 or AL2 or AL1 and 2.

1. Press the **ALARM1** or **ALARM 2** Button once. The Display will change from the current time to wake up time and begin flashing. The **ALARM1** or **ALARM 2** indicator lights.
2. While the Display is flashing, press repeatedly and release the **▶▶** Button until the desired hour appears in the Display.

Note: For 12 Hour format, there is a PM INDICATOR (PM) located in the upper left-hand corner of the Display. This indicator will light when the time range falls within the “PM” range when setting the Alarm. The time is in the “AM” range if this indicator is not lit. It is important that the “AM” or “PM” setting is correct for proper operation of the Alarm function.

3. Press repeatedly and release the **◀◀** Button until the correct minute is displayed.
4. To complete the setting process press the respective **ALARM1** or **ALARM 2** button once.

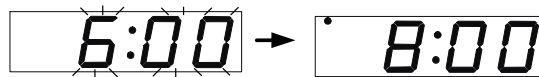

Note: Press **ALARM1** or **ALARM 2** buttons once to turn the respective Alarm function off. The respective **ALARM1** or **ALARM 2** Indicator will go off.

DIMMER OPERATION

1. Set the DIMMER SWITCH to “HI” for a bright LED Display under normal room illumination.
2. Set the DIMMER SWITCH to “LOW” for a dim LED Display in the dark.

RADIO RECEPTION

1. Press the POWER Button to turn on the unit. The POWER INDICATOR lights.
2. Set the FUNCTION Selector to AM or FM position.
3. Set the FM MODE Selector to MONO or STEREO if FM Band is selected.

Note:

- i. For FM reception, the unit provides FM MONO/STEREO selection. If you select FM STEREO band, the FM STEREO Indicator will light when a strong FM stereo broadcast is received.
 - ii. To receive a weak (noisy) FM station, set the FM MODE Selector to MONO position. The reception then may be improved, but the sound is monaural (MONO).
4. Turn the TUNING Knob for the desired station and adjust the volume using the VOLUME Control.
 5. When you have finished listening press the **POWER** Button again to turn the unit “Off”. The POWER Indicator goes “Off”.

TIPS FOR BEST RADIO RECEPTION

AM

The AM ferrite bar antenna is inside the cabinet. If AM reception is unsatisfactory, try turning the entire unit slightly until you find the direction that provides the best reception for the desired station.

FM

Make sure the FM Wire Antenna is extended to its full length. You may have to vary the direction of the Wire Antenna to find the position that provides the best reception.

CD PLAYER OPERATION

Note: This CD player plays not only the commercial CDs but also self-compiled CD-R/RW discs.

1. Press the **POWER** Button to turn the unit "On". The POWER INDICATOR lights.
2. Set the **FUNCTION** Selector to the **CD** position.
3. Open the CD Door. Carefully place an audio CD, with its label side upward, on the center spindle and close the CD Door.
4. Two dashes "- -" flash while the Player reads the table of contents of the disc. The Display will show the total number of tracks on the disc for a few seconds and then return to the current time.

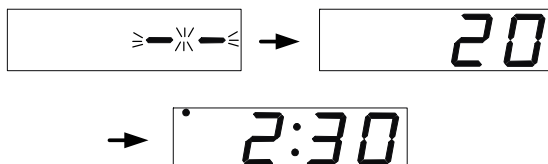

Note: If the disc is inserted incorrectly, or if the disc is badly scratched and cannot be read by the player, "no" will appear in the Display for a few seconds, and then the Display returns to the current time.



5. Press **▶||** Button to begin playback. The Display will briefly show "01" (Track 01) and playback on track 01 begins. After a few seconds the Display returns to the current time.

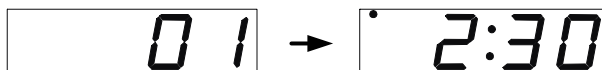

If you want to check the Track under playing press the **DISPLAY** Button once.

6. Adjust **VOLUME** Control to obtain the desired sound level from the Speakers.
7. To suspend play, press the **▶||** Button (# 6) once. The Display will briefly show the flashing current track and then return to current time.

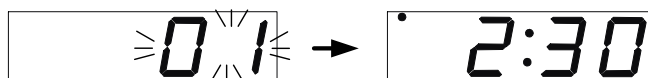

To resume playing, press the **▶||** Button again.

8. You can choose to play your favorite track directly by pressing either the Skip Forward **▶▶** Button or the Skip Backward **◀◀** Button until the desired track number appears in the Display. For example Track No. 12 is selected. Playback will begin on the selected track.

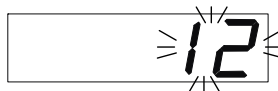

9. To locate a particular passage within a track, keep the Search Forward **▶▶** Button or Search Backward **◀◀** Button depressed until it is found.
10. To repeat a particular track, press the **PLAY MODE** Button once in STOP mode. The **REPEAT** INDICATOR appears and flashes.
11. Press the **◀◀** or **▶▶** Button to select the particular track e.g. track 08 to be repeated. While the track number is flashing, press the **▶||** Button to start playback. Track 08 will be repeated continuously.

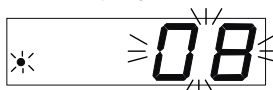

12. If the REPEAT ONE function is selected during playback, the selected track will be played automatically and repeats continuously.
13. To repeat the entire CD, press the **PLAY MODE** Button twice in STOP mode. The **REPEAT INDICATOR** lights steadily in the Display.

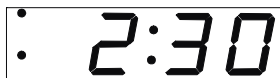

14. Press the **▶||** Button to start playback from Track 1. The entire CD will be repeated continuously until the **STOP ■** Button is pressed.
15. If the REPEAT ALL function is selected during playback, the entire CD will be played automatically and repeats continuously.
16. To cancel repeat playback, press the **PLAY MODE** repeatedly until the **REPEAT INDICATOR** goes off.
17. To stop playing, press the **STOP ■** Button once.

RANDOM PLAYBACK

This function allows all the tracks on a disc to be played in a random sequence.

1. Load your disc and wait until the total track number is displayed.
2. Press the **PLAY MODE** Button three times in STOP mode. The **RANDOM** Indicator comes “On”.



3. Press the **▶||** Button. A track will be selected and playback begins. The Display will show the track number of the selected track momentarily and return to current time.
 4. If the Random function is selected during playback, press **▶||** Button to start random playback.
- Note:** The Player will stop automatically after all the tracks on the disc have been played.
5. To cancel random playback, simply press the **PLAY MODE** Button again. **RANDOM** Indicator goes “Off”.
 6. When you wish to turn off the CD Player, press the **POWER** Button again.

CD PROGRAMMED PLAY

This function allows the tracks to be played in a programmed sequence. You may program a track or tracks to play more than once if desired.

Note: i. Programming can only be done while the player is in the Stop mode. If a disc is playing press the **■ STOP** Button to stop playback before performing the programming steps below.

ii. Programmed play will be disabled if Random function is activated.

1. Turn the unit “On”, select CD function and load the disc in the player. Wait until the total track number is displayed.
2. Press the **PROG** (PROGRAM) Button. The **PROG** (PROGRAM) Indicator flashes and the Display briefly shows “**P 01**” then “00” appears and flashes indicating that you can select the first track to be programmed.

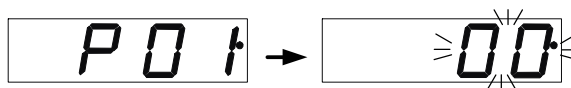

- Press the Skip Forward **▶▶** Button or the Skip Backward **◀◀** Button to select the first song to be programmed. For example to program the song in track 8 in the first preset memory **"P 01"**.



- Press the **PROG** Button again to store selection. The selected track is now registered in the program memory number 01 and the Display advances to **"P 02"** then **"00"** appears and flashes indicating that you can select the next track to be programmed in the memory.

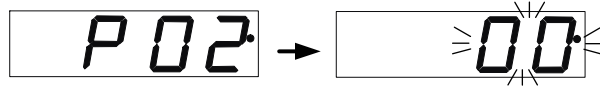

- Press the Skip Forward **▶▶** Button or the Skip Backward Button **◀◀** to select the next song to be programmed and press the **PROG** Button to store selection.
- You may repeat steps #2 - #5 to program as many as 20 tracks.
- Press **PLAY/PAUSE ▶||** Button to start playing in the programmed sequence.



- After all the programmed tracks have been played the player stops but the program remains in the memory.
 - Press the **PROG** Button and then the **PLAY/PAUSE ▶||** Button to begin programmed playback again.
- To clear the program from the memory after the disc stops:
 - Press the **PROG** Button and then the **STOP ■** Button or
 - Open the CD Door or
 - Press the **POWER** Button to shut off the unit or
 - To switch to other Function using the **FUNCTION** Selector...

PROGRAM REPEAT PLAYBACK

You may use the PROGRAM and REPEAT features together to repeat a programmed sequence of tracks.

- Enter the desired tracks in the program memory as describe under section **"CD PROGRAMMED PLAY"**.
- Press the **PLAY MODE** Button once for single track repeat or twice for "All Tracks Repeat" as desired. The **PROGRAM** and **REPEAT** Indicator both light.



- Press **▶||** Button to start Program Repeat Playback. The programmed track or tracks will play repeatedly until the **STOP ■** Button is pressed.

Notes on CD-R/RW Discs

- Because of non-standardized format definition/production of CD-R/RW, playback quality & performance are not guaranteed.
- Manufacturer is not responsible for the playability of CD-R/RW due to recording conditions such as PC performance, writing software, media ability, etc.
- Do not attach a label or seal to either side of the CD-R/RW disc. It may cause a malfunction.

ALARM OPERATION

This unit provides wake to BUZZER, RADIO or CD alarm function.

WAKE TO RADIO, CD OR BUZZER

1. Refer to “SETTING ALARM TIME” in page 6 to set the desired wake up time (s).
2. Set the **FUNCTION** Selector to the desired wake up mode, i.e. RADIO, CD or BUZZER.
3. Press the **ALARM 1** and/or **ALARM 2** Button once. **ALARM 1** and / or **ALARM 2** Indicator comes “On”. The respective alarm time(s) flashes briefly in the Display which will return to show the current time in a few seconds.



4. When the preset wake up time is reached the selected wake up mode turns “On”. The respective ALARM Indicator flashes. The alarm will continue to sound and last for 60 minutes and then turn off automatically. The alarm remains set and will turn the radio on again at the same time on the following day.
5. To stop the alarm sound before it turns off automatically, press the **POWER** Button once. The alarm sound stops but the alarm remain set and will turn the radio on again at the same time on the following day.
6. To cancel the alarm function press the **ALARM1** and/or **ALARM 2** buttons once. The respective ALARM indicator goes off.

Notes:

- i. If you have chosen “Wake to RADIO” alarm mode, make sure that you have tuned to a station and adjusted the volume to a comfortable level.
- ii. If “Wake to CD” alarm mode is selected, make sure that there is a CD in the player and the volume is set to a comfortable level.
- iii. In “Wake to CD” alarm mode, Buzzer will sound instead if no CD is inserted.
- iv. In “Wake to CD” alarm mode, the CD will play for about 60 minutes, regardless the total playing time of the disc.

SNOOZE OPERATION

1. When the alarm sounds (buzzer, radio or CD), you can press the SNOOZE Button to extend the alarm time by 6 minutes. The buzzer, radio or CD will then turn on again.
2. The SNOOZE operation can be repeated several times within the 60 minutes alarm duration until the **POWER BUTTON** is pressed.

SLEEP TIMER OPERATION

You can use the SLEEP Timer to fall asleep to Radio or CD for 90, 60, 30 or 15 minutes intervals.

SLEEP OPERATION

1. In Power On mode, operate the Radio or CD as usual. Adjust the volume to the desired level.
Note: The level you selected for "Sleep to Music" is the same level you will hear when the alarm turns "On".
2. Press the SLEEP button. The display will show 90 minutes of playing time and then return to show the current time mode in 3 seconds.



The radio will automatically turn off after 90 minutes has elapsed.

ADJUSTING THE SLEEP PERIOD

1. With the unit In POWER ON mode, press the SLEEP Button repeatedly to select the amount of sleep time as follows:

	Display	SLEEP Timer Off Time
1 st Press	90	Shut off in 90 Minutes
2 nd Press	60	Shut off in 60 Minutes
3 rd Press	30	Shut off in 30 Minutes
4 th Press	15	Shut off in 15 Minutes
5 th Press	Current time	Shut off in 15 Minutes

2. The unit will automatically turn off after the preset sleep time has elapsed. However, if you want to turn the radio off before the preset sleep time has elapsed, press the POWER Button to switch the power off. The POWER INDICATOR turns off.

Note:

- i. If 90 or 60 minutes sleep time is selected and you are playing a CD that is only 48 minutes long, for example, playback will stop at the end of the disc.
- ii. Make sure the **FUNCTION** Selector is set to the CD or RADIO position before you press the **SLEEP** Button. No sound will be heard if the **FUNCTION** Selector is set to the **BUZZER** position.

SLEEP AND WAKE TO BUZZER/CD/RADIO

1. Follow steps 1 to 4 (shown in P.6) under the "SETTING ALARM TIME" section to set the ALARM time.
2. Set your desired "WAKE TO" source as describe above in the "ALARM OPERATION" section. Follow step 1 (shown above) under the "ADJUSTING THE SLEEP PERIOD" section to set the desired SLEEP time.

The Radio is now programmed to turn off automatically at the Sleep Time you selected and then to turn on again at the preset "Alarm Time".

COMPLIANCE WITH FCC REGULATIONS

This equipment has been tested and found to comply with the limits for a Class B Digital Device, pursuant to Part 15 of the FCC Rules. These limits are designed to provide reasonable protection against harmful interference in a residential installation. This equipment generates, uses and can radiate radio frequency energy and, if not installed and used in accordance with the instructions, may cause harmful interference to radio communications. However, there is no guarantee that interference will not occur in a particular installation. If this equipment does cause harmful interference to radio or television reception, which can be determined by turning the equipment off and on, the user is encouraged to try to correct the interference by one or more of the following measures:

- Reorient or relocate the receiving antenna.
- Increase the separation between the equipment and receiver.
- Connect the equipment into an outlet on a circuit different from that to which the receiver is connected.
- Consult the dealer or an experienced radio technician for help.

WARNING

Changes or modifications to this unit not expressly approved by the party responsible for compliance could void the user's authority to operate the equipment.

CARE AND MAINTENANCE

1. Avoid operating your unit under direct sunlight or in hot, humid or dusty places.
2. Keep your unit away from heating appliances and sources of electrical noise such as fluorescent lamps or motors.
3. For better Clock Display clarity, avoid operating the unit under direct sunlight or in strong room illumination.
4. Unplug the unit from the electrical power outlet immediately in case of malfunction.

COMPACT DISC CARE

- Handle the disc only by its edges. Never allow your fingers to come in contact with the shiny, unprinted side of the disc.
- Do not attach adhesive tape, stickers etc., to the disc label.
- Clean the disc periodically with soft, lint-free, dry cloth. Never use detergents or adhesive cleaners to clean the disc. If necessary, use a CD cleaning kit.
- If disc skips or gets stuck on a section of the disc, it is probably dirty or damaged (scratched).
- When cleaning the disc, wipe in straight lines from the center of the disc to the edge of the disc. Never wipe in circular motions.
- To remove a disc from its storage case, press down on the center of the case and lift the disc out, holding it carefully by the edges.
- Fingerprints and dust should be carefully wiped off the disc's recorded surface with a soft cloth. Unlike conventional records, compact discs have no grooves to collect dust and microscopic debris so gently wiping with a soft cloth should remove most particles.



CLEANING THE UNIT

- To prevent fire or shock hazard, disconnect your unit from the AC power source when cleaning.
- The finish on the unit may be cleaned with a dust cloth and cared for as other furniture, Use caution when cleaning and wiping the plastic parts.
- If the cabinet becomes dusty wipe it with a soft dry dust cloth. Do not use any wax or polish sprays on the cabinet.
- If the front panel becomes dirty or smudged with fingerprints it may be cleaned with a soft cloth slightly dampened with a mild soap and water solution. Never use abrasive cloths or polishes as these will damage the finish of your unit.

CAUTION: Never allow any water or other liquids to get inside the unit while cleaning.

TROUBLE SHOOTING GUIDE

If you experience difficulties in the use of this CD Clock Radio, please check the following or call 1-800-777-5331 for Customer Service.

Symptom	Possible Cause	Solution
Noise or sound distorted on AM or FM broadcast	Station not tuned properly for AM or FM. FM: Wire antenna is not extended. AM: The bar antenna is not positioned correctly	Retune the AM or FM broadcast station. Extend the FM wire antenna. Reposition the unit until the best reception is obtained.
FM STEREO Indicator does not light	You have tuned to a mono station or the station is too weak. MONO mode is chosen	Select another FM station. Select FM STEREO mode.
AM or FM no sound	Unit not set to AM or FM band. Volume at minimum	Slide the Function selector to AM or FM position. Increase Volume
CD player will not play	Unit not in CD function mode. CD is installed incorrectly. If the CD is self-compiled, the media used may not be compatible with the player.	Select CD function mode. Insert CD with label side up. Use better quality blank media and retest.
CD skips while playing	Disc is dirty or scratched.	Wipe CD with clean cloth or use another disc.
CD Intermittent sound	Dirty or defective disc Dirty Pick Up lens Player is subject to excessive shock or vibration	Clean or replace the defective disc Use a CD-lens cleaning disc to clean the lens Relocate the player away from shock or vibration

SERVICE

Please refer to the instructions on the enclosed warranty card for returning your unit for service. When returning the unit, please remove any batteries to prevent damage to the unit in transit and/or from possible battery leakage. We are not responsible for batteries returned with the product or for the cost of replacement.

Distributed by:

Spectra Merchandising International, Inc.

Chicago Industry Tech Park

4230 North Normandy Avenue

Chicago, IL 60634, U.S.A.

Please have model number ready, for Customer Service, call 1-800-777-5331

Printed in China